

New TV SOCKETS



COMMON
MECHANISM



ANTHRACITE
COVER



TECH COVER



WHITE COVER

A SIMPLE RANGE
FOR ADVANCED PERFORMANCES

New TV SOCKETS

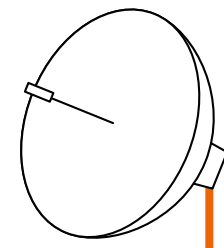

- Optimum performance
- New safe and intuitive wiring system
- Simple: only one product reference for each function

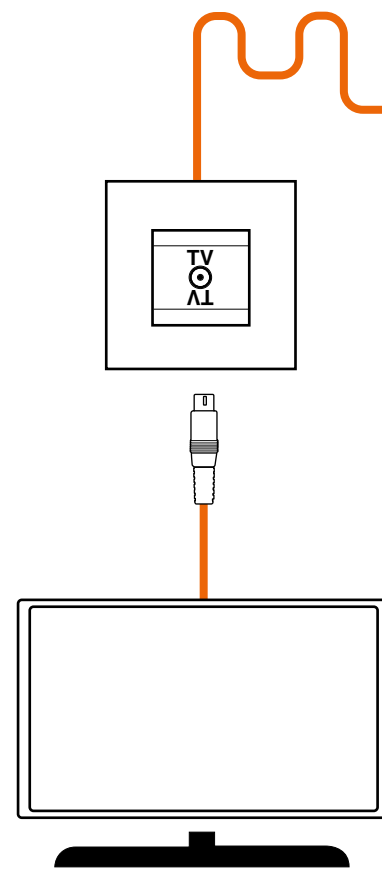

OPTIMUM PERFORMANCES

Low attenuation, optimised over the requirements of the EN50083-4 standard (<1 dB in DVBT and Satellite Band).
 Suitable also for the new television devices in UHD (Ultra High Definition).
 Reduction of the amplification required for the operation.

Performance graphs

IN-SAT

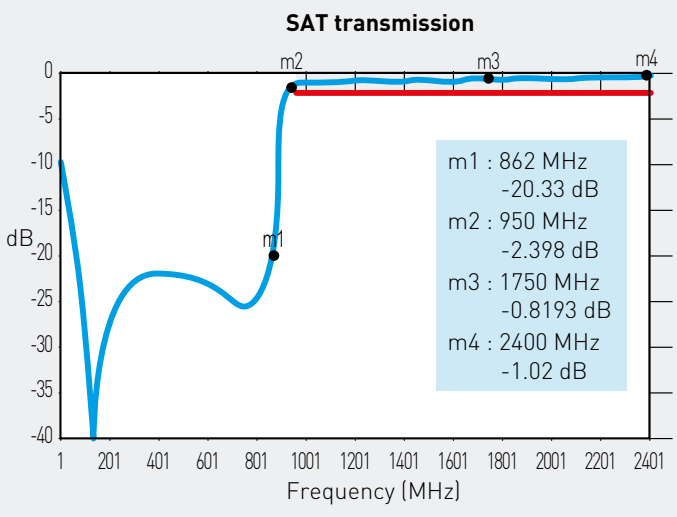

IN-TV

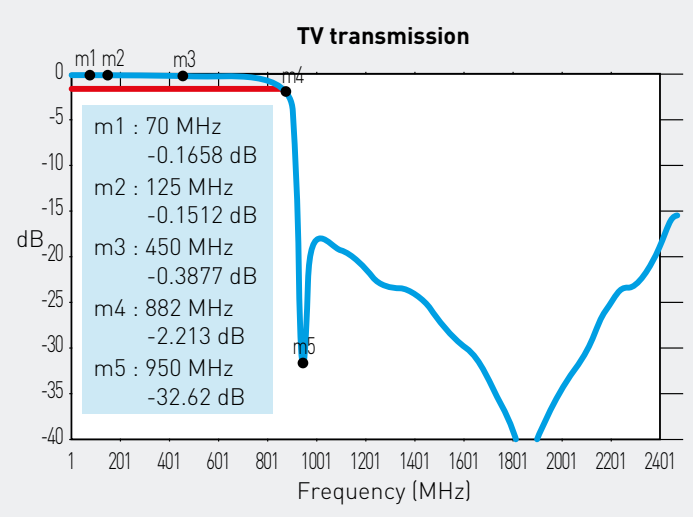

CONFORMITY

All new TV jacks complies with reference European regulations (EN 50083-2, EN 50083-4) and have successfully passed the certification tests conducted by an independent external body.

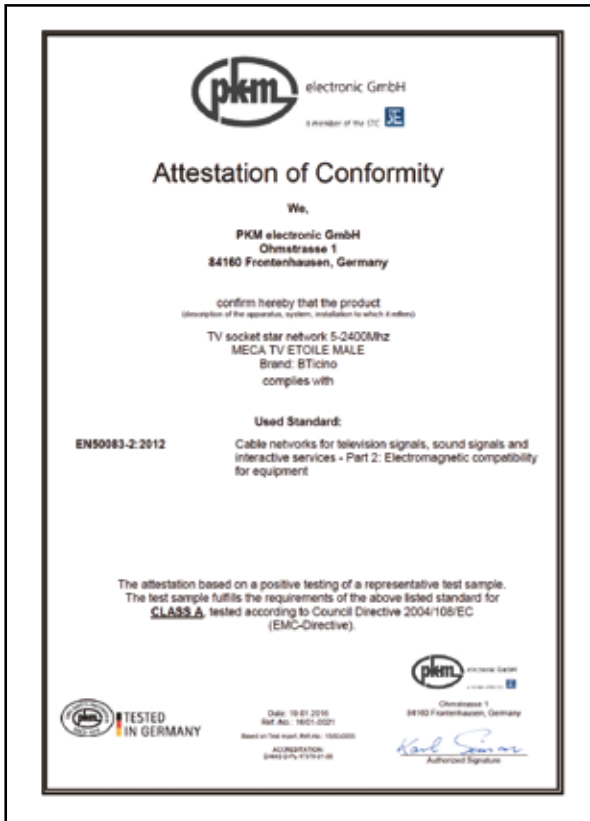

Conformity certificate for all the sockets of the range



NEW WIRING SYSTEM

- The new wiring system of the BTicino TV sockets allows an intuitive connection thanks to the complete opening of the clamp and the direct display of the cable insertion zone.
- Improved efficiency thanks to the clamp shielding in Class A (thanks to the Class A shielding of the clamps).



Safe

thanks to a cable holding higher than 12 Kg



If the copper core of the coaxial cable is visible, the contact is sure.

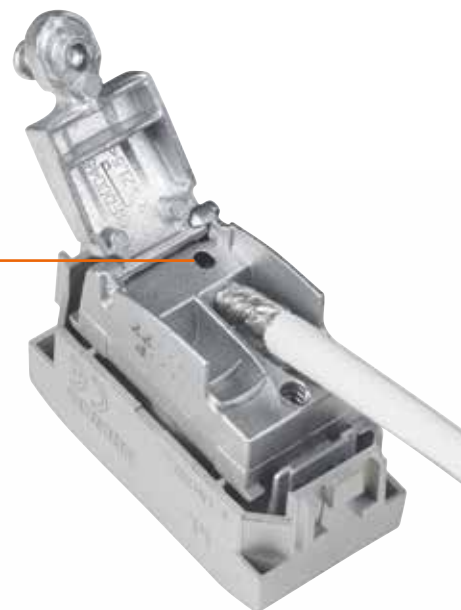

New TV SOCKETS

ONLY ONE REFERENCE FOR EACH TV SOCKET OUTLET

Simplification

for all BTicino ranges, the aesthetic covers are supplied with the engine.

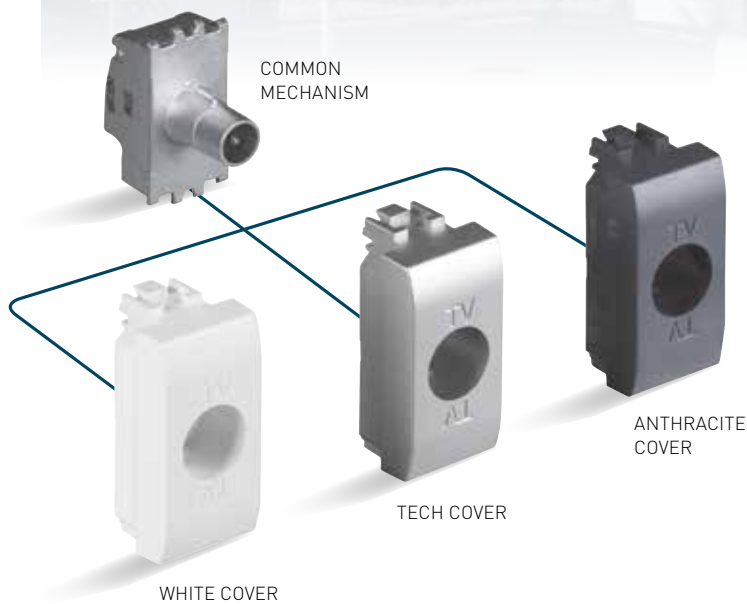

Selection guide

1. Choose your wiring devices offer
2. Choose the function (e.g.: star socket, passthrough socket, satellite socket, etc.)

Done!

For Axolute and Livinglight, available in 3 different finishes (white, tech, anthracite), the color of the mechanism is no longer a problem.

The product reference is always the same!



1 PRODUCT
REFERENCE

■ A COMPLETE RANGE

The **new TV sockets offer** is perfectly suitable for different installation modes of a TV system (single home or apartment block) and for the different wiring modes (star or passthrough installations).

Star TV and SAT installation

Typically used in new installations.

Installation of passthrough and terminal sockets

Often used in refurbishments of old systems.

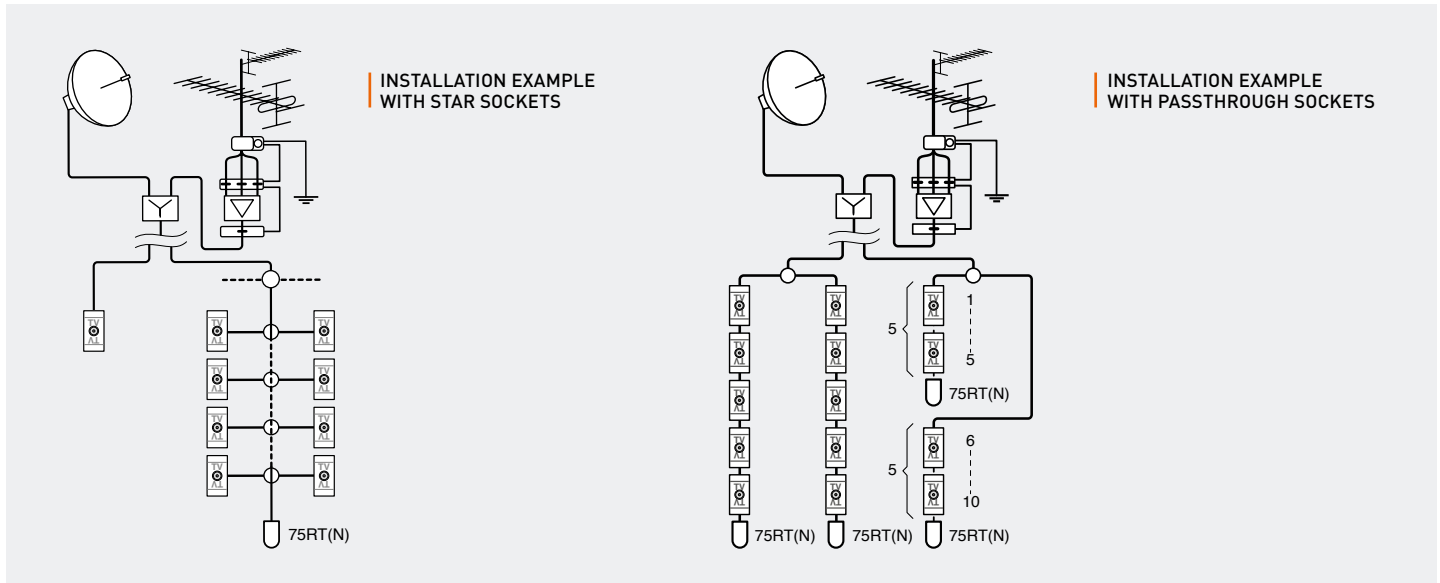

■ QUICK SELECTION TABLE

		AXOLUTE		LIVINGLIGHT		MÀTIX		MAGIC	LUNA	VELA
		1 m	2 m	1 m	2 m	1 m	2 m	1 m	1 m	1 m
		Star TV socket	H4202D		LN4202D	LN4202M2D	AM5202D A5202D AM5202ABD	5202D	C4202CD	681574
		Passthrough TV socket -14dB	H4202P14		LN4202P14		AM5202P14 A5202P14	5202P14	C4202P14	681575
		Terminal TV socket -10dB	H4202P10		LN4202P10		AM5202P10 A5202P10	5202P10	C4202P10	681576
		Type-F star satellite socket	H4202F		LN4202F		AM5202F A5202F			681577
		TV/SAT star socket demixed	H4214D	H4214M2D	LN4214D	LN4214M2D	AM5214D A5214D			
		TV/R/SAT star socket demixed		H4210M2D		LN4210M2D		AM5210M2D A5210M2D		
		TV/RD socket for cable operator (Telenet)		H4211M2C		LN4211M2C		A5211M2C		

TV - FM - SAT SOCKETS



H4202D



LN4202D



C4202CD



H4202P10



LN4202P10



C4202P10



H4202P14



LN4202P14



5202P14



LN4202M2D



H4202F



LN4202F



AM5202F

Item

STAR TV SOCKET

Star coaxial socket for single-user aerial systems, also remote powered and centralised, and single-user / centralised satellite systems with current and signal transfer for channels selection; shielded connection clamps with captive screws - Ø 9.5 mm; male connector - supplied in package with common mechanism and, where provided, with front covers in different aesthetic finishes

H4202D	Axolute
LN4202D	Livinglight
AM5202D	Màtix
AM5202ABD	Antibacterial Màtix
A5202D	Màtix Ivory
5202D	Magic
C4202CD	Luna
681574	Vela
	as above - 2 modules
LN4202M2D	Livinglight

Item

PASSTHROUGH TV SOCKET

Passthrough coaxial socket, -14dB attenuation, for centralised TV systems, also remote powered, and centralised satellite systems with current and signal transfer for channels selection - shielded connection clamps with captive screws - Ø 9.5 mm; male connector - supplied in package common mechanism and, where provided, with front covers in different aesthetic finishes - 1 module

H4202P14	Axolute
LN4202P14	Livinglight
AM5202P14	Màtix
A5202P14	Màtix Ivory
5202P14	Magic
C4202P14	Luna
681575	Vela

Item

TERMINAL TV SOCKET

Terminal coaxial socket, -10dB attenuation, for centralised TV systems, also remote powered, and centralised satellite systems with current and signal transfer for channels selection; shielded connection clamps with captive screws - Ø 9.5 mm - male connector - incorporated impedance final adapter 75 Ω - supplied in package with common mechanism and, where provided, with front covers in different aesthetic finishes - 1 module

H4202P10	Axolute
LN4202P10	Livinglight
AM5202P10	Màtix
A5202P10	Màtix Ivory
5202P10	Magic
C4202P10	Luna
681576	Vela

Item

TYPE-F SAT SOCKET

Type-F coaxial socket - impedance 75 ohm - screw hook - supplied in package with common mechanism and, where provided, with front covers in different aesthetic finishes - 1 module

H4202F	Axolute
LN4202F	Livinglight
AM5202F	Màtix
A5202F	Màtix Ivory
681577	Vela

NOTE: pictures of Axolute and Livinglight items represent the product ref. indicated to which one of the three front cover plates (white, tech or anthracite) available in the package is already fitted.

TV - FM - SAT SOCKETS



H4214D LN4214D AM5214D A5214D



LN4214M2D H4214M2D



H4210M2D LN4210M2D AM5210M2D



H4211M2C

Item **STAR TV/SAT DEMIXED SOCKET**

Star demixed coaxial socket for single-user aerial systems, also remote powered and shunting centralised, and for single-user / shunting centralised satellite systems with current and signal transfer for channels selection; Ø 9.5 mm male TV connector - type F SAT connector - supplied in package with common mechanism and, where provided, with front covers in different aesthetic finishes - 1 module

H4214D	Axolute
LN4214D	Livinglight
AM5214D	Màtix
A5214D	Màtix Ivory
	as above - 2 modules
LN4214M2D	Livinglight
H4214M2D	Axolute

NOTE: for an optimum use of the product, all the outputs must be used

Item **STAR TV/R/SAT DEMIXED SOCKET**

Star demixed coaxial socket for single-user aerial systems, also remote powered and shunting centralised, and for single-user / shunting centralised satellite systems with current and signal transfer for channels selection, and for radio systems; Ø 9.5 mm male TV connector - type F SAT connector and female radio Ø 9,5 mm - supplied in package with common mechanism and, where provided, with front covers in different aesthetic finishes - 2 modules

H4210M2D	Axolute
LN4210M2D	Livinglight
AM5210M2D	Màtix
A5210M2D	Màtix Ivory

NOTE: for an optimum use of the product, all the outputs must be used

Item **TV-RD SOCKET FOR CABLE OPERATOR**



Double coaxial shunted socket for TV and FM- LMC reception - Ø 9.5mm - Belgium (Telenet operator)

H4211M2C	Axolute
LN4211M2C	Livinglight
A5211M2C	Màtix

NOTE: pictures of Axolute and Livinglight items represent the product ref. indicated to which one of the three front cover plates (white, tech or anthracite) available in the package is already fitted.

CODE REPLACEMENT TABLE

Table of the main item codes.

	AXOLUTE		LIVINGLIGHT		MÀTIX	
	New code	Replaced codes	New code	Replaced codes	New code	Replaced codes
Star TV socket 	H4202D	HC4202D	LN4202D	L4202D	AM5202D	AM5173D
		HD4202D		N4202D		
		HS4202D		NT4202D		
Type-F SAT socket 	H4202F	HC4269F	LN4202F	L4269F	AM5202F	AM5173DF
		HD4269F		N4269F		
		HS4269F		NT4269F		
Star TV/R/SAT demixed socket 	H4210M2D	HC4210D	LN4210M2D	L4210D	AM5210M2D	AM5173SAT
		HD4210D		N4210D		
		HS4210D		NT4210D		

	MAGIC		LUNA	
	New code	Replaced codes	New code	Replaced codes
Star TV socket 	5202D	5173D	C4202CD	C4202D

BTicino SpA
Viale Borri, 231
21100 Varese - Italy
www.bticino.com